

67

# OPERATING INSTRUCTIONS & SERVICE MANUAL

SOLID-STATE STEREO CONTROL AMPLIFIER

## SANSUI AU-555

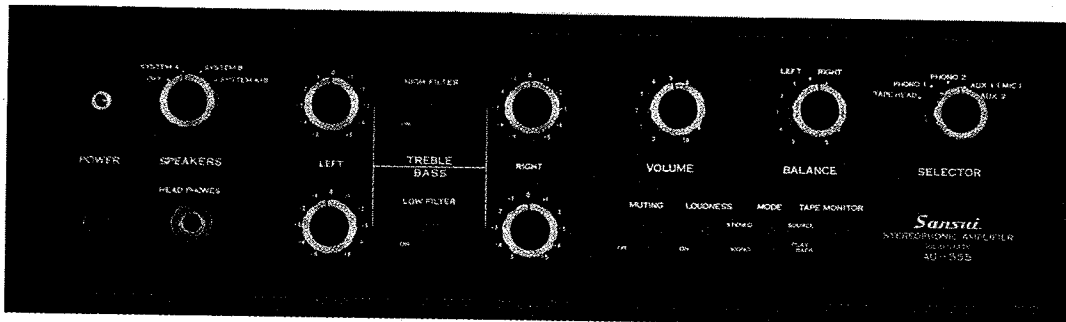

**Sansui**<sup>®</sup>

SANSUI ELECTRIC COMPANY LIMITED

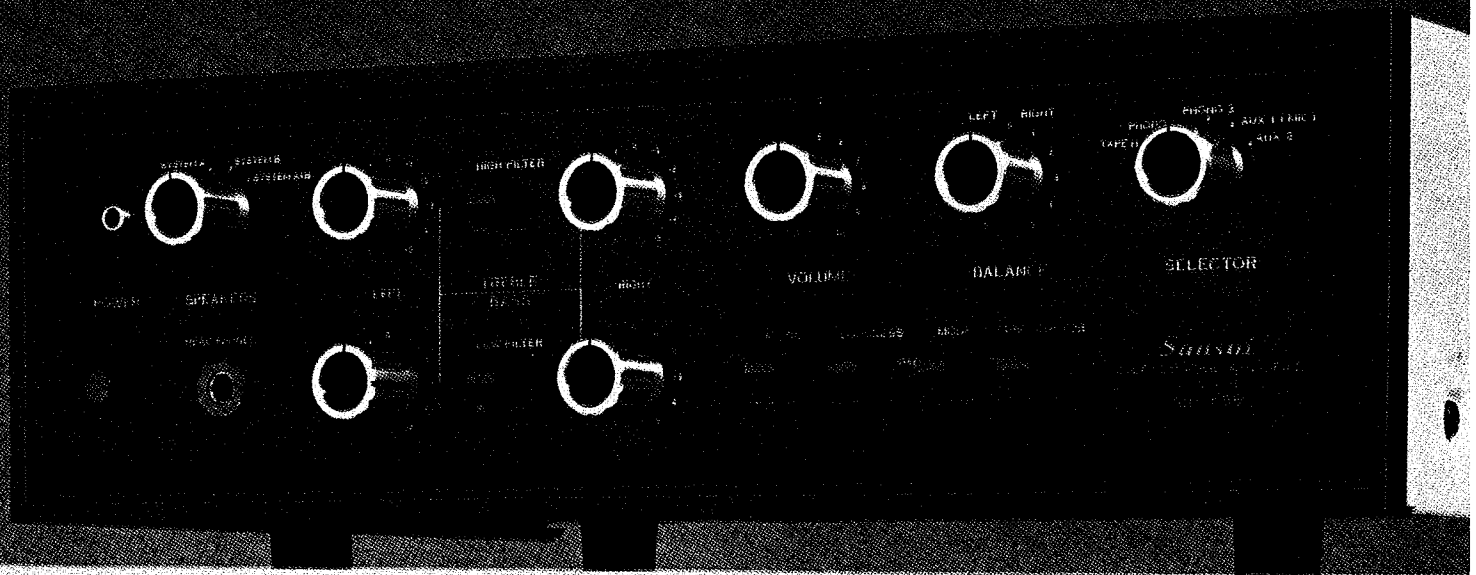

# SWITCHES AND CONTROLS

## Treble Control

The TREBLE control consists of two separate knobs, one for each channel.

The TREBLE control does for the high frequencies what the BASS control does for the lows. To increase the intensity of the treble tones, turn the TREBLE control clockwise. To decrease the treble loudness, turn the TREBLE control counterclockwise.

## Power Indicator

The power indicator glows when the POWER switch is pushed on. The indicator lamp remains lit while the amplifier is on.

## Bass Control

The BASS control consists of two separate knobs, one for each channel.

The BASS control is used to boost or to cut the low-end response, according to your taste, speaker response and listening conditions. With the BASS control in the mid-position (marked 0), the bass tone will sound exactly as recorded or broadcast. To increase the intensity of the bass tones, turn the BASS control clockwise. To decrease the bass loudness, turn the BASS control counterclockwise.

## Power On-off Switch

Power is applied to the amplifier when the POWER switch is pushed. To turn off, push the POWER switch again. The rear AC outlet marked SWITCHED is controlled by this switch.

## Loudness Switch

This switch is used to compensate for the natural hearing deficiency of the human ear in the extreme bass and treble ranges at low listening levels. When this switch is on. It converts the VOLUME control to a loudness compensated control. Switch it on to listen at low volume levels.



## Mode Switch

**STEREO**—Use this position for all stereo programs.

**MONO**—Use this position for all monophonic programs. This position connects the left or right input or the L+R program to both speakers.

### MODE SWITCH FUNCTION

STEREO	SIGNAL	R—	L—	→	→	→	SOUND
MONURAL	SIGNAL	R—	→	→	→	→	SOUND
		L—	→	→	→	→	

## Selector Switch

This switch selects from among the various program sources connected to the input jacks on the rear panel of the amplifier. Below are the switch positions and their functions:

**TAPE HEAD**—Selects a tape deck without built-in pre-amplifier. The tape speed should be 19 cm/sec or 7½ ips.

**PHONO 1**—Selects a record player connected to the PHONO 1 inputs on the rear panel.

**PHONO 2**—Selects a record player connected to the PHONO 2 inputs on the rear panel.

**AUX 1 (MIC)**—Selects a tuner, MPX adaptor or microphone connected to the AUX 1 (MIC) inputs on the rear panel.

**AUX 2**—Selects a tuner, MPX adaptor or other components connected to the AUX 2 inputs on the rear panel.

# SWITCHES AND CONTROLS

## Speaker Selector Switch

This switch enables you to choose between one set of speakers ("A" system) and another set ("B" system), which may be installed in the same room or in another part of the house. It also has a position for running all speakers at once, as well as another that cuts them all out headphone listening.

## Headphones Jack

This jack will accept any standard phone plug but dynamic type stereo headphones are recommended.

The headphones are used in conjunction with the SPEAKER selector switch. This switch enables you to listen over the headphones while keeping main and/or remote speakers on or off. Headphones may also be used for tape monitoring.

## High Filter Switch

This FILTER is used to reduce record scratch, tape hiss or other high-frequency noises.

## Low Filter Switch

The LOW FILTER is used to reduce turntable rumble or other low-frequency noises.

## Volume Control

The VOLUME control adjusts the over-all sound level of both channels. To increase the volume, turn the control clockwise.

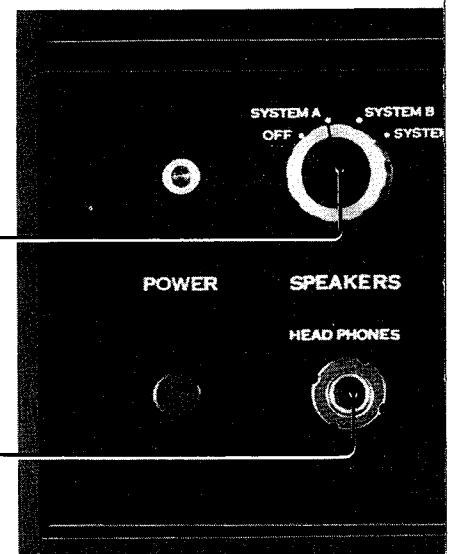

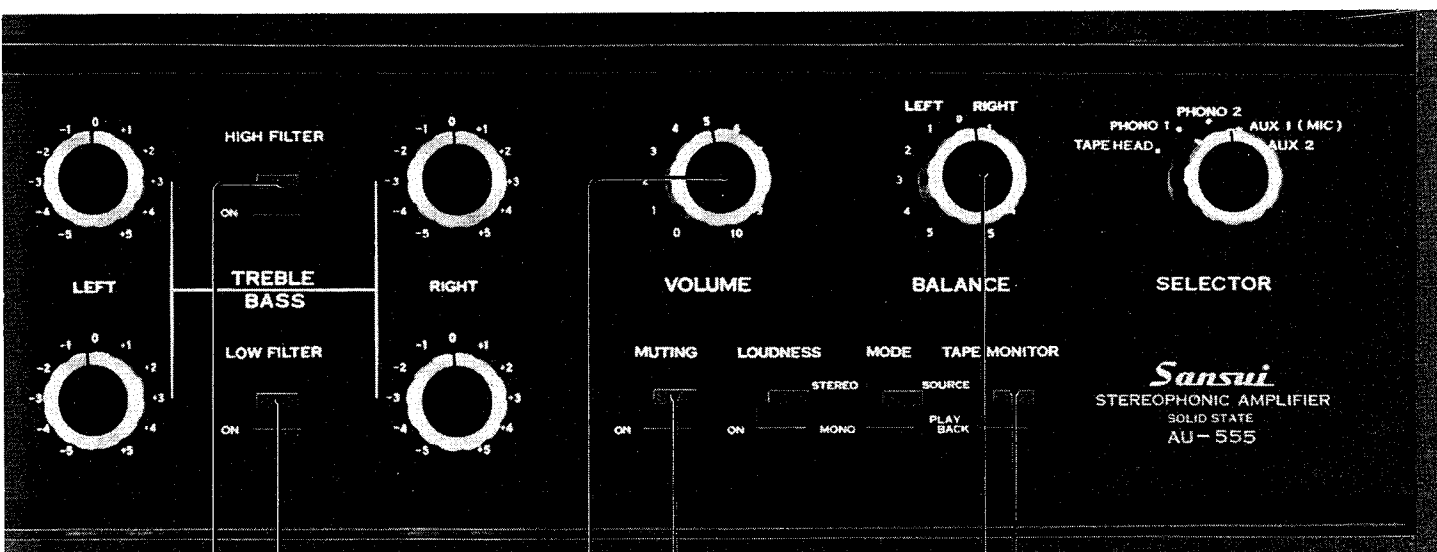

### Muting Switch

This switch is used to suppress interstation tuning noise or to reduce volume temporarily during record playing. When this switch is on, the volume is attenuated by 20db over the whole frequency range.

### Balance Control

This control is used to adjust for equal sound levels from both left and right channels. To increase the sound level on the right and decrease the left, turn the control clockwise. To increase the sound level on the left and decrease the right, turn the control counterclockwise.

### Tape Monitor Switch

This switch enables you to compare the recorded tape with the original program. When the switch is in the PLAY BACK position, the recorded tape is heard from the loudspeakers. The monitoring process is only possible with a three-head tape machine. IMPORTANT: When not in use, make sure the switch is in the SOURCE position.

# SPEAKERS

Two sets of any 4- to 16-ohm speakers can be used with the AU-555. One set may be installed as the main system, the other may be installed in any room in the house. Both systems are controlled by the SPEAKER selector on the front panel of the amplifier.

## Connection

No more than  $\frac{1}{4}$ -inch of insulation should be re-

moved from the end of a speaker cable, since any greater length of exposed wire is likely to cause shorts at the terminals on the rear of the amplifier. All wire strands should be tightly twisted. As illustrated below, push the jack button down and hold with one hand, insert the end wires of the speaker cable into the hole with the other hand, and release the button.

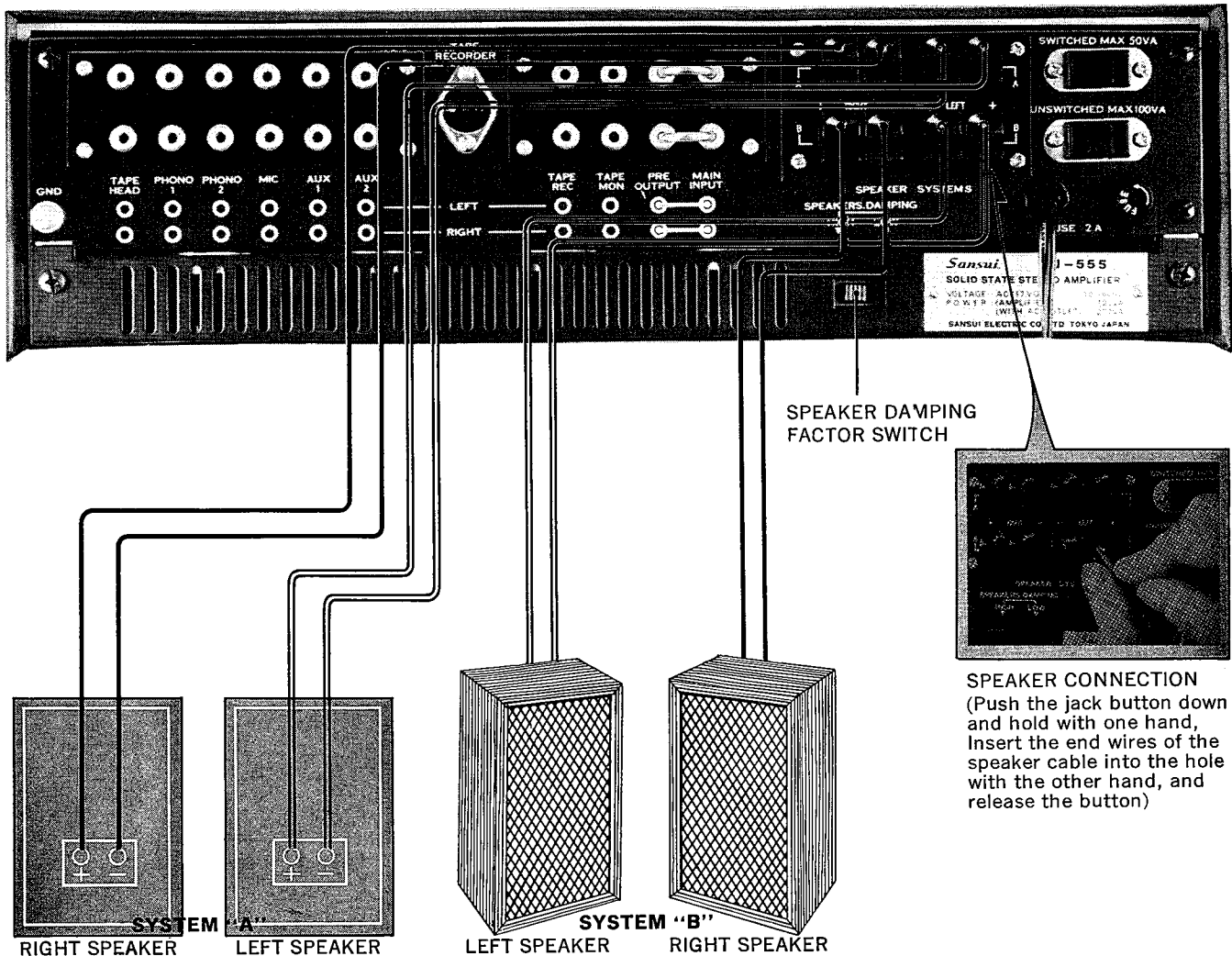

---

## One Speaker System

To connect the main set of speakers (SYSTEM-A) to the amplifier:

1. Connect the (+) terminal of the speaker on your right (as viewed from the listening position) to the RIGHT SYSTEM-A (+) terminal on the rear of the amplifier.
2. Connect the lead from the common speaker terminal (marked -, C, G etc.) to the RIGHT SYSTEM-A (-) terminal on the rear of the amplifier.
3. Connect the (+) terminal of the left speaker to the LEFT SYSTEM-A (+) terminal on the rear of the amplifier.
4. Connect the lead from the common speaker terminal (marked -, C, G etc.) to the LEFT SYSTEM-A (-) terminal on the rear of the amplifier.
5. Turn the SPEAKER selector to SYSTEM-A.

## Additional Speakers

If you wish to connect another set of speakers in the same room or remotely, you can connect such speakers to the SPEAKER SYSTEM-B terminals of each channel as indicated in the preceding section. When the SPEAKER selector is in the SYSTEM-B position, you will hear sound from the speakers connected to the SYSTEM-B terminals. With the selector in the A+B position, the sound comes from all the speakers connected to the amplifier.

## Phasing of Speakers

Stand about 10 feet in front of and midway between the speakers and listen to any monophonic reproduction. If the speakers are correctly phased, the sound will seem to come from between the speakers. If the sound is not directly in front of you, the speakers are incorrectly phased. To correct this, switch the amplifier off and reverse the leads to one speaker.

## Damping Factor Switch

This switch enables you to select between two damping factors in order to match the type of speakers used. Set it to either its HIGH (d.f., 45) or LOW (d.f., 12) position while actually listening to the speakers in operation.



# OPERATIONS

## — RECORD PLAYER

## — MICROPHONES

### Record Player Connections

The following procedures are recommended for use with a record player or turntable utilizing a magnetic cartridge with an output voltage between 2mV and 10mV:

1. Connect the left channel output of a stereo turntable to the LEFT PHONO 1 (or PHONO 2) input jack on the rear of the amplifier.
2. Connect the right channel output of the turntable to the RIGHT PHONO 1 (or PHONO 2) input jack.
3. If a monophonic player or turntable is used, it may be connected to either RIGHT or LEFT PHONO input jack.
4. Plug the turntable's power source cord into the AC outlet marked SWITCHED on the rear of the amplifier. The power supply for the turntable will then be controlled by the POWER switch on the front panel of the amplifier.

**NOTE:** A record player with a constant amplitude cartridge such as crystal or ceramic is not recommended for use with the AU-555 from a standpoint of tone quality. If such a player must be used, connect the output of the player to the AUX input jack on the rear of the amplifier.

### Operation

1. Turn the SELECTOR switch to PHONO 1 or PHONO 2, depending on the turntable you wish to hear.
2. Set the MODE switch to STEREO. If a monophonic turntable is used, set the MODE switch to MONO.
3. Switch the turntable ON, and select the correct speed for the record to be played.
4. Place the needle on the record. When monophonic records are played on a stereo player, follow the same procedures as for stereophonic records for

better results.

5. Adjust the BALANCE control to obtain equal sound from both right and left channels.
6. Use all other controls and switches according to personal taste and listening conditions.

### Humming and Howling

Care must be taken never to place a record player on or too near a speaker enclosure. Otherwise the vibration of the speaker enclosure is transmitted to the player and causes howling. It is best to keep these components completely separated, but if this is impossible, to place a thick cushion between them.

Humming is a phenomenon caused by incomplete or incorrect player-amplifier connections. If this occurs, check to make sure that all connections are complete and that the connecting wire is sufficiently thick.

### Microphones

One or two microphones can be connected to the MIC inputs on the rear of the amplifier. Use high-impedance 10-k crystal, dynamic or velocity microphones for optimum performance.

### Connections

If two microphones are used, connect one to the RIGHT MIC input and the other to the LEFT. If only one microphone is used, connect it to either RIGHT or LEFT MIC input.

### Operation

1. Turn the SELECTOR switch to AUX 1 (MIC).
2. If two microphones are used, set the MODE switch to STEREO or MONO for mixing the two input signals. If only one microphone is used, set the MODE switch to MONO.
3. Use all other controls and switches according to taste and listening conditions.

**NOTE:**

- \* The amplifier can accept high-impedance microphones only.
- \* Don't use excessively long cable.
- \* Since the tone controls can be used separately for each channel, the microphones can be used in the best way even when one is for music and the other for voice. The amplifier will have increasing uses if programs from the microphones are to be recorded on tapes.
- \* Components connected to the AUX 1 inputs cannot be used simultaneously with the microphones.

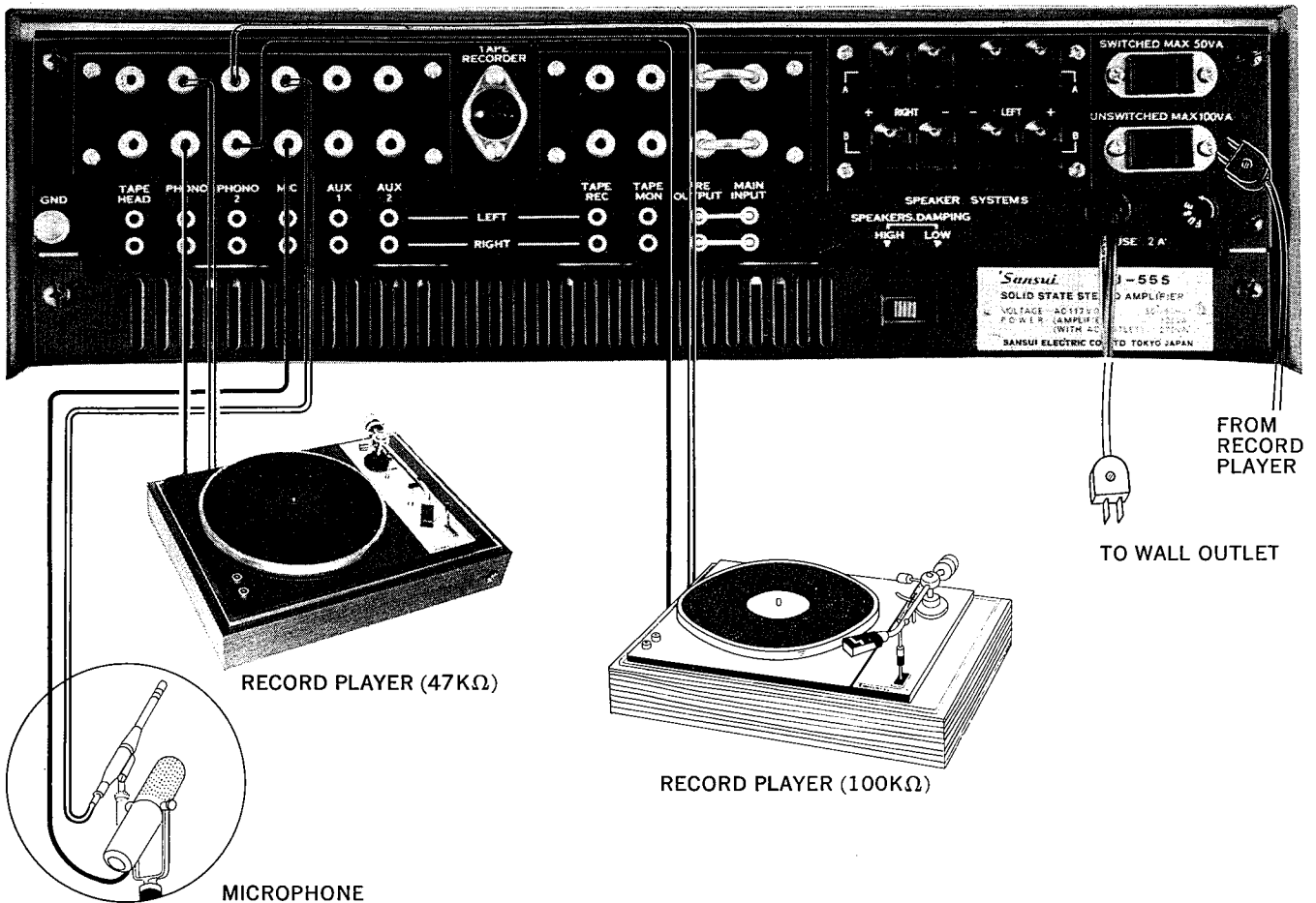

# OPERATIONS

## — TUNERS

## — PRE-AND MAIN AMPLIFIERS

### Tuner Connections

- a. **Stereo Tuner**—Connect the left channel output of a stereo tuner to the left channel AUX-1 or AUX-2 input, and the right channel output to the right channel AUX-1 or AUX-2 input.
- b. **Monophonic Tuner**—Connect the output of a monophonic tuner to either right or left channel AUX-1 (or AUX-2) input.
- c. **FM Tuner with FM-MPX Adaptor**—Connect the output of an FM tuner to the input of an FM-MPX adaptor. The outputs of the adaptor should be connected in the same manner as a stereo tuner.

### Operation

#### Stereo Tuner

1. Turn the SELECTOR switch to AUX 1 or AUX 2.
2. Set the MODE switch to STEREO.
3. Select the station desired with the tuning dial.
4. Use all other controls and switches according to taste and listening conditions.

#### Monophonic Tuner

1. Turn the SELECTOR switch to AUX 1 or AUX 2.
2. Set the MODE switch to MONO.
3. Select the station desired with the tuning dial.
4. Use all other controls and switches according to taste and listening conditions.

#### FM Tuner with FM-MPX adaptor

1. Turn the SELECTOR switch to AUX 1 or AUX 2.
2. Set the MODE switch to STEREO.
3. Select the station desired with the tuning dial.
4. Set the FM-MPX adaptor to STEREO.
5. Use all other amplifier controls and switches according to taste and listening conditions.

**NOTE:** Before connecting and operating the tuner and FM-MPX adaptor, be sure to look up the manufacturer's information.

### Pre-and Main Amplifiers

The AU-555's pre- and main amplifier sections can be used independently. To use in this manner, remove the PM connectors from the jacks marked PRE OUTPUT and MAIN INPUT on the rear of the amplifier. An additional main amplifier can then be connected to the PRE OUTPUT and an additional pre-amplifier to the MAIN INPUT. When the additional pre-amplifier is connected, only the SPEAKER switch is usable on the front panel of the AU-555. Thus, tone and volume should be adjusted by means of corresponding controls on the additional pre-amplifier. When an additional main amplifier is connected, all the controls and switches on the front panel of the AU-555 are usable.

### Multiplex-channel Amplifier Stereo

The independent pre- and main amplifier sections make the AU-555 more versatile. One of their most exciting uses is for Multiplex channel Amplifier stereo. In this stereo system, the woofer, mid-range and tweeter response is divided on the input side of the amplifier and each speaker has its own optimum amplifier. The sound is superbly clean and natural, with matchless fidelity.

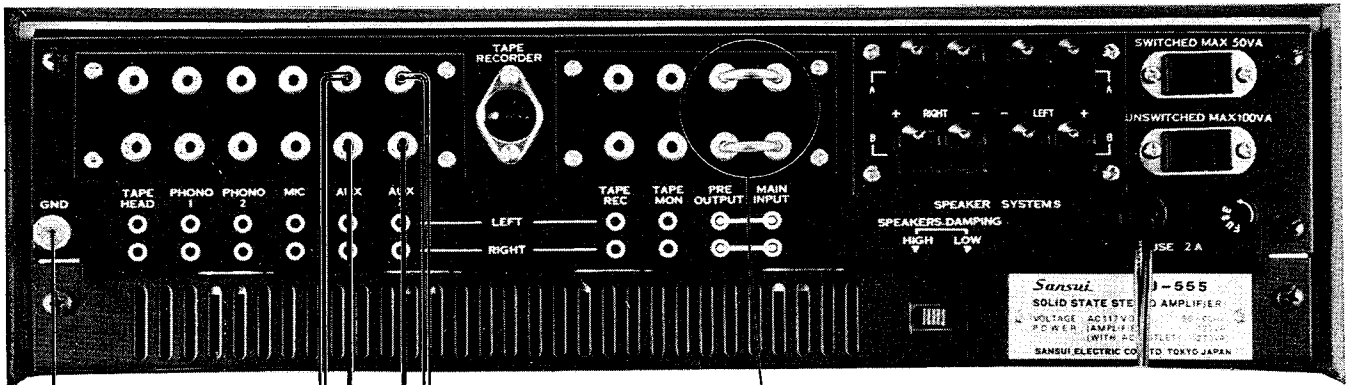

GROUND  
See "MAINTENANCE"

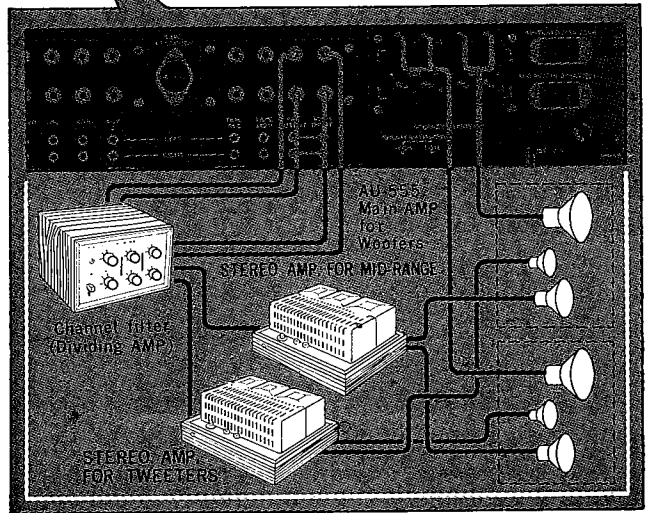
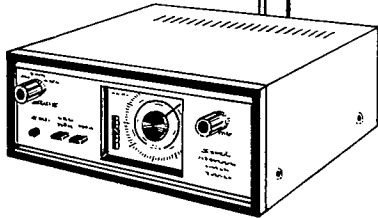
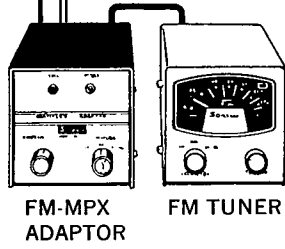

# OPERATIONS

## — TAPE RECORDERS

## — TAPE DECKS

### Tape Deck and Tape Recorders

A tape recorder can be connected to record from, and playback through, the amplifier. A tape deck without a built-in playback preamplifier can be connected to playback through the amplifier. When a 3-head tape recorder with separate recording and playback heads is used, the quality of tape recordings made from the amplifier can be compared with the source material while it is being recorded.

### Tape Deck

**To connect a tape deck without playback preamplifier:**

1. Connect the left channel output of the tape deck to the LEFT TAPE HEAD input on the rear of the amplifier.
2. Connect the right channel output of the tape deck to the RIGHT TAPE HEAD input.
3. If a monophonic tape deck is used, connect it to either RIGHT or LEFT input.

**To listen totapes with tape deck:**

1. Turn the SELECTOR switch to TAPE HEAD. The TAPE HEAD indicator on the front panel of the amplifier will glow.
2. Switch the tape deck ON.
3. If a monophonic tape deck is used, set the MODE switch to MONO. If a stereo tape deck is used, set the MODE switch to STEREO.
4. Adjust the BALANCE control to obtain equal sound from both right and left channels.
5. Use all other controls and switches according to taste and listening conditions.

### Tape Recorders

Both DIN plug and pin jack tape recorders can be connected to the amplifier.

### Connection

**DIN plug tape recorder**—Plug into the TAPE/PLAY socket near the upper left corner on the rear panel of the amplifier.

**Pin jack tape recorder**—Connect the left channel recording input of the tape recorder to the LEFT REC jack and the right channel recording input to the RIGHT REC jack. Connect the left channel playback output of the tape recorder to the LEFT MON jack and the right channel playback output to the RIGHT MON jack.

### Recording

1. Turn the SELECTOR switch to the program source to be recorded.
2. If a stereo tape recorder is used, set the MODE switch to STEREO. If a mono tape recorder is used, set the MODE switch to MONO.
3. Switch the tape recorder ON and set its controls for recording operation.
4. Use all other controls and switches as appropriate.

### Playback

1. Turn the TAPE MONITOR switch PLAY BACK.
2. Switch the tape recorder ON and set its controls for playback operation.
3. Use all other controls and switches of the amplifier according to taste and listening conditions.

### Monitoring

Same as above. (See "NOTE:" continued on P. 14)

**NOTE:**

1. Tape recorded sound cannot be controlled by the switches and controls on the front panel of the amplifier. They control sound from the speakers only.
2. For better results, record directly through the AU-555, rather than through microphones placed in front of the speakers.
3. When the TAPE MONITOR switch is not in

use, make sure the switch is in the SOURCE position.

4. Tape recorders referred to in this section include only those with built-in playback preamplifiers. Those without should be connected and operated as tape decks.
5. Tape monitoring is possible only with 3-head tape recorders, i.e., those with separate playback and recording heads.

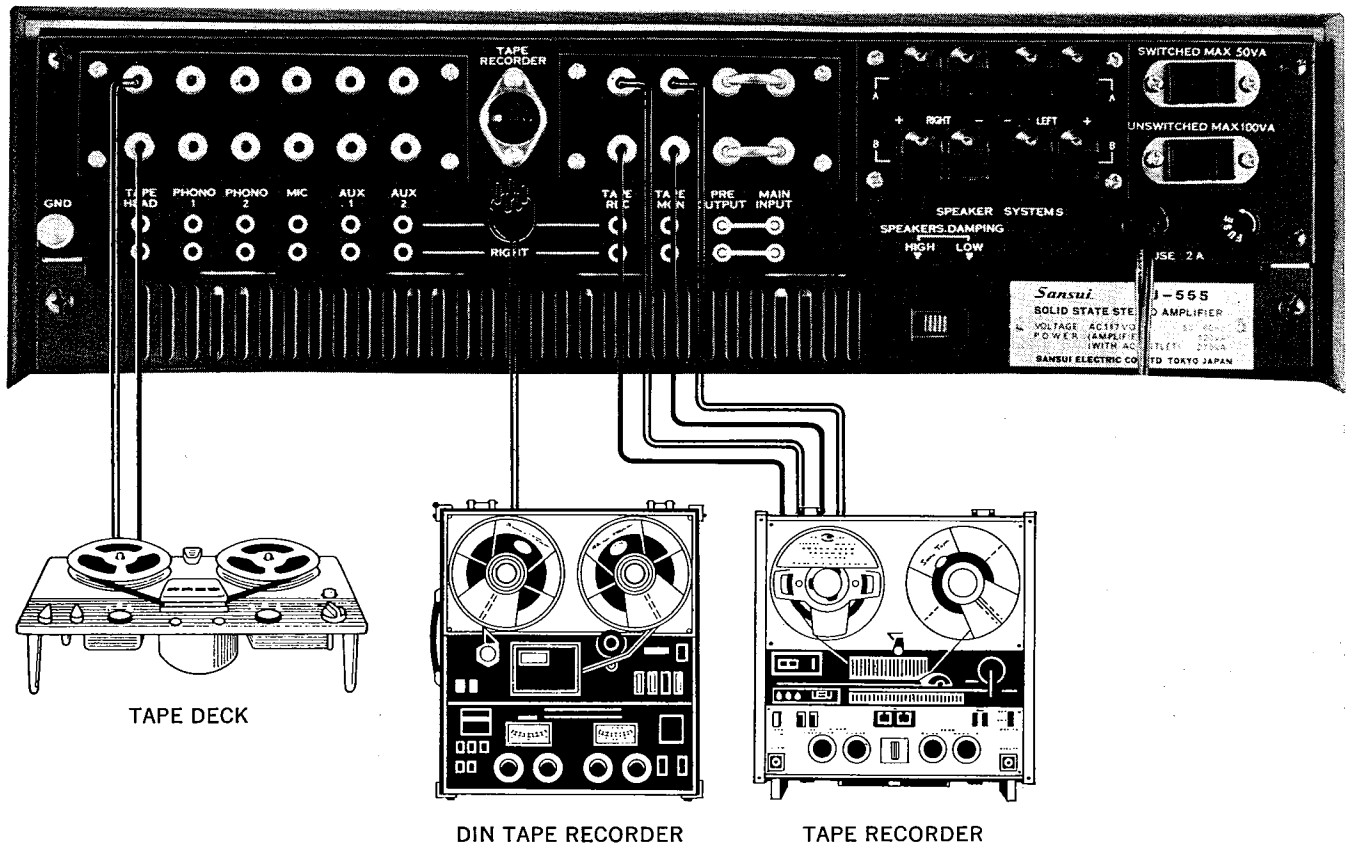

# MAINTENANCE

## PM Connectors

**Warning:** Be sure to push the POWER switch OFF before removing the PM connectors.

The PM connectors hook up the PRE OUTPUT and MAIN INPUT terminals on the rear panel of the amplifier so that the pre-and main amplifiers can be used individually and separately. When the PM connectors are removed, the pre-and main amplifier circuits are opened. They should not be removed except when connecting additional pre-and/or main amplifiers for multi-channel stereo. Refer to the section titled PRE-AND MAIN AMPLIFIERS.

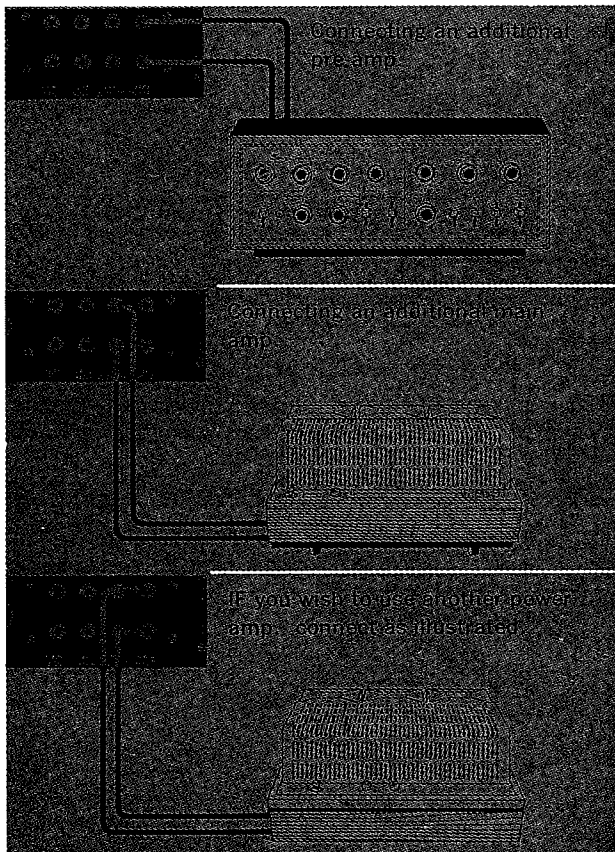

## If the Protector Circuit Lights Up...

It means that the AU-555's circuit has been activated to cut incoming current as soon as it exceeds the allowable limit to prevent the power transistors from becoming damaged. When this happens, the PROTECTOR circuit is closed and no sound comes from the speakers. As soon as this happens, turn off the amplifier's power supply for about 15 seconds, then turn it back on. If all the speakers are still silent, immediately turn the power off, locate and eliminate the source of trouble. Probable cause: a shorted output circuit or excessive input.

## Quick-Acting Fuses

These fuses for right and left channels are also designed to protect the power transistors by blowing instantly if shorting occurs between connections at the speaker terminals. If, after the POWER switch is turned on and the POWER indicator lights up, neither channel operates or only one operates normally, is either because one or both quick-acting fuses have blown. In this case, remove the power plug from its outlet, screw out the fuse on the printed circuit board (F-1058) located inside the bonnet of the amplifier, and check to see if the fuses are blown. Replace them with identical 2 AGD fuses after finding and eliminating the source of trouble that caused them to blow.

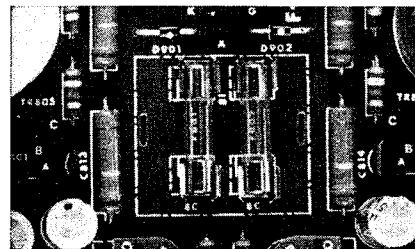

## Power Fuse

Should the amplifier fail to operate, the probable cause is either a power stoppage or a blown fuse. To check, remove the AU-555's power plug from its outlet, unscrew the fuse holder on the rear panel, and remove the fuse. If it is blown, replace it with a new glass-tubed fuse of the same capacity (2A) after determining and eliminating the trouble source that caused the fuse to blow. Using wire or a fuse of different capacity as a stop-gap measure is dangerous and should be avoided.

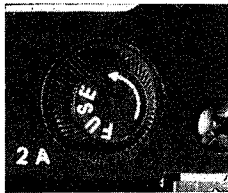

## AC Outlets

Two AC outlets have been provided on the rear panel of the amplifier to serve as power supply sources for tape recorders, record players or other components used with the AU-555. The upper outlet marked SWITCHED is controlled by the POWER switch on the front panel of the amplifier.

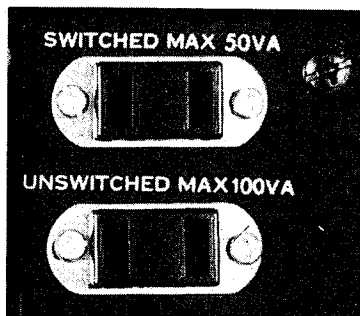

## Wire Connections

When connecting tape machines, record players or other components to the AU-555, be sure to use shielded wire. The use of an ordinary cord or vinyl wire may cause humming and buzzing. The length of the shielded wire should be shorter than 5 feet. Be sure that all lead wires between the amplifier and components are properly connected. If the connections are loose or in touch with other parts, the amplifier will not function properly, may pickup noise, and even breakdown over a period of time. Also, be sure to read the manufacturer's instructions for any component before connecting it to the AU-555.

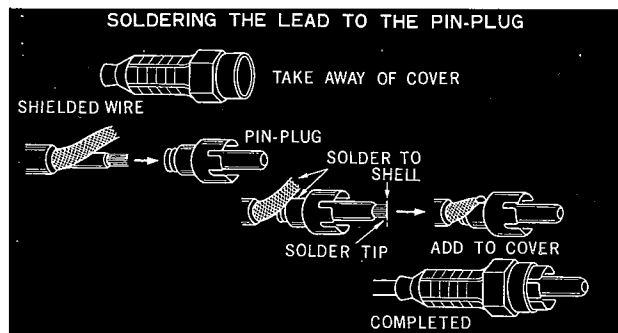



# MAINTENANCE

## Grounding

Connect one end of vinyl or enameled wire to the terminal screw marked GND on the rear of the amplifier, attach a copper plate to the other end, and bury it underground. Whenever an outdoor AM antenna is used, grounding becomes necessary. In all cases, grounding is desirable since it allows a better S/N ratio to be obtained. To ground an entire audio system, connect the grounding wire of each component used to this terminal.

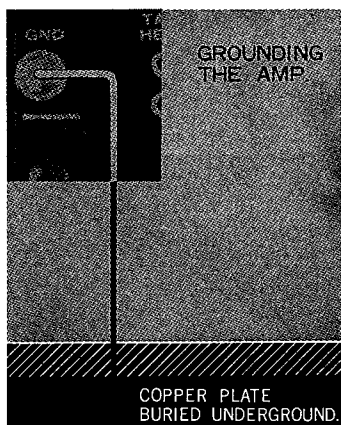

## Voltage Selecting Plug

This plug is located inside the bonnet of the amplifier and has been set to the voltage of your area prior to shipment. If the amplifier is ever moved to an area with another voltage requirement, this plug must be changed to the proper voltage of the new area. To change, remove the bonnet from the amplifier, remove the plug from the voltage socket you have been using, and plug the arrow head into the appropriate voltage requirement of 100V, 117V, 220V or 240V.

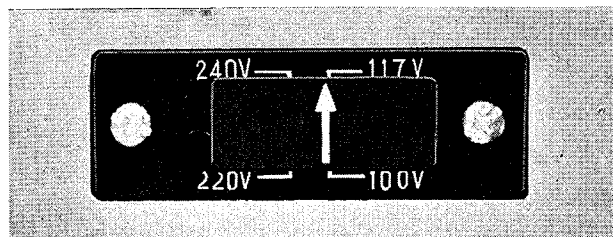

## Location

Transistors are relatively susceptible to heat. Although proper ventilation for cool running is one of the design considerations of the AU-555, some simple precautions are necessary:

1. If the amplifier is installed in a cabinet, leave sufficient open space on all three sides of the unit for adequate ventilation.
2. If the amplifier is installed on an open shelf without a cabinet, keep it out of direct sunlight.

## Phasing

The right and left speakers must be properly phased. The speakers for the two channels must push the sound wave out together. If one pushes while the other pulls, there is sound cancellation at some frequencies or in some listening locations. Incorrect phasing is evidenced by loss of bass when you are listening to a monophonic record on a stereo record player at a point midway between the two speaker systems. If incorrect, reverse the speaker connections (+ and -) of either speaker system.

## Where to Place

Since transistors are extremely susceptible to heat, the AU-555 has been designed to diffuse heat through the top and rear of its case. Therefore, special consideration should be given to where it will be used before installing the tuner. It should not be operated in a place where it is exposed directly to the sun, near radiators or other heat-generating sources, and it should never be mounted in an air-tight cabinet. Finally nothing should be placed on top of it.

## Damping Factor Switch

This switch enables one of two damping factors to be selected to match the type of speaker system used. Set it to either its HIGH (DF 45) or LOW (DF 12) position while actually listening to the speakers in operation.

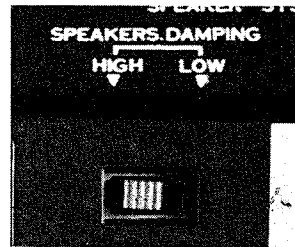

# SPECIFICATIONS CHARACTERISTICS

## MAIN AMP. SECTION

### POWER OUTPUT

MUSIC POWER (IHF): 60W at 4 ohms  
50W at 8 ohms

CONTINUOUS POWER (each channel):  
25/25W at 4 ohms  
20/20W at 8 ohms

HARMONIC DISTORTION: Less than 0.5%

### INTER MODULATION DISTORTION

(60 Hz; 7,000 Hz=4:1) Less than 0.8%

POWER BANDWIDTH: from 20 to 30,000 Hz at 8 ohms  
(0.5% distortion)

FREQUENCY RESPONSE: from 20 to 80,000 Hz  $\pm 1$ db  
(at normal listening level.)

CHANNEL SEPARATION: better than 50db

HUM AND NOISE(IHF): better than 100db

INPUT SENSITIVITY: 1V at rated output

OUTPUT IMPEDANCE: from 4 to 16 ohms

DAMPING FACTOR: 12 and 45 at 8 ohms load

INPUT IMPEDANCE: 100 K ohms

SPEAKER SELECTOR SWITCH: 1) OFF 2) A 3) B  
4) A+B

## PRE AMP. SECTION

### OUTPUT VOLTAGE

MAXIMUM OUTPUT VOLTAGE: 3 V

RATED OUTPUT VOLTAGE: 1 V (150 $\Omega$ )

HARMONIC DISTORTION: Less than 0.1% at rated  
output voltage

FREQUENCY RESPONSE: from 20 to 50,000 Hz  $\pm 1$ db

HUM AND NOISE (IHF) (at rated output voltage)

VOLUME AT MINIMUM: better than 100db

PHONO 1 AND 2: better than 80db

TAPE HEAD: better than 75db

AUX 1 AND 2: better than 80db

INPUT SENSITIVITY (for rated output: at 1,000 Hz)

PHONO 1: 2 mV (47 K ohms)

PHONO 2: 2 mV (100 K ohms)

TAPE HEAD (19 cm/s): 1.5 mV (200 K ohms)

AUX 1: 200 mV (100 K ohms)

MIC: 3.5 mV (10 K ohms)

AUX 2: 140 mV (100 K ohms)

TAPE MONITOR: 150 mV (100 K ohms)

RECORDING OUTPUT (at rated input): 140 mV

### CONTROLS AND SWITCHES

BASS CONTROL: 20 Hz +16db~-16db

TREBLE CONTROL: 20,000 Hz +13db~-13db

LOUDNESS CONTROL: 50Hz +8db, 10,000Hz +2.5db  
(volume control at -30db)

LOW FILTER: 30 Hz, -12db

HIGH FILTER: 20,000 Hz -10db

MUTING SWITCH: -20db (20~20,000 Hz)

MODE SWITCH: 1) STEREO 2) MONO (L+R)

SELECTOR SWITCH: 1) TAPE HEAD (19 cm/sec)  
2) PHONO 1 3) PHONO 2  
4) AUX 1 (MIC) 5) AUX 2

TAPE MONITOR SWITCH: 1) SOURCE 2) PLAY BACK

## OTHER SPECIAL FEATURES

Direct tape monitor. Headphones jack. Muting switch.

Main-amplifier input jack. Pre-amplifier output jack.

DIN connector for tape recorder.

Mic input (AUX 1). DF Control switch.

## TRANSISTORS AND DIODES

TRANSISTOR: 22

DIODE: 6

THERMISTOR: 4

S.C.R.: 1

## POWER REQUIREMENTS

POWER VOLTAGE: 110V, 117V, 220V, 240V.  
50~60 Hz

POWER CONSUMPTION: 120VA (at max. signal)

## DIMENSIONS

WIDTH: 15"

HEIGHT (Excluding rubber stand): 4<sup>3</sup>/<sub>8</sub>"

DEPTH (Excluding Knob): 10<sup>7</sup>/<sub>8</sub>"

## WEIGHT

WEIGHT: 17.4 lbs

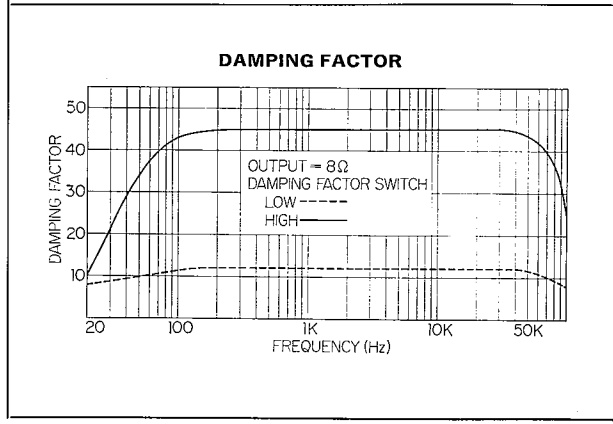
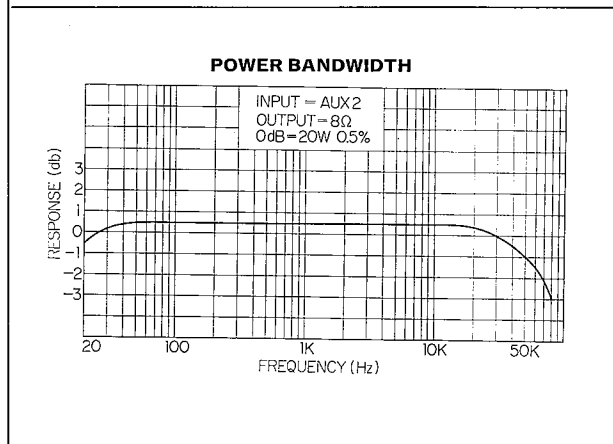
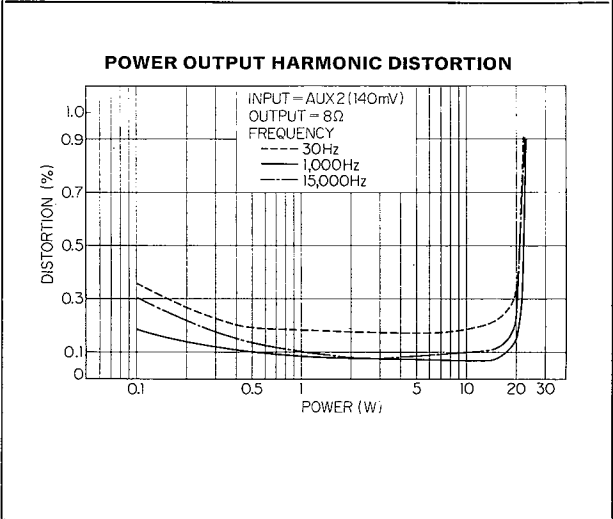
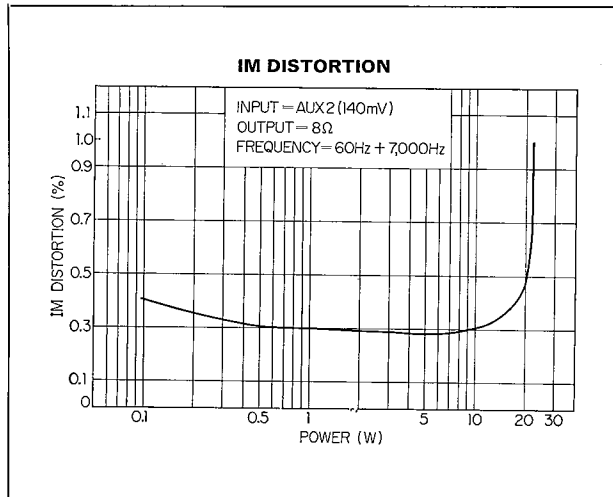
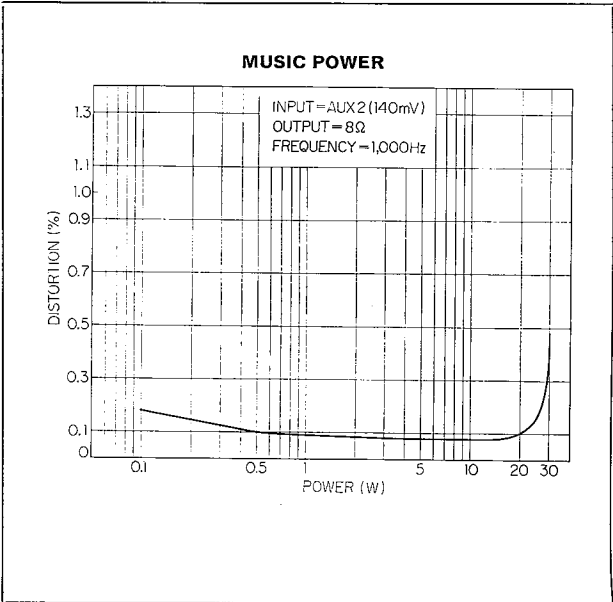

\* All rights reserve specifications subject to change without notice.

# GENERAL TROUBLESHOOTING CHART

## HOW TO USE THIS SERVICE MANUAL

The troubleshooting charts in this manual help you isolate the cause of the trouble to a particular unit or part. If you can identify the nature of the trouble with that in these charts and can find the part number in the column under the CHECK POINT, look up the PARTS LIST on page 29~34. Following each part number in the PARTS LIST are number-letter combinations indicating the position of the part on the circuit diagram and the printed circuit sheet. These co-ordinate numbers and letters appear along the outer edge of the circuit diagram and the printed circuit sheet diagram in this manual. The numbers run from top to bottom and the letters from left to right. Finally, repair or replace the defective part.

In some instances, the amplifier which is operating satisfactorily develops hum or noise as listed on this page. In this case, eliminate the trouble source as indicated in the column under WHAT TO DO.

If you are confronted with a trouble not covered here or if you have any questions concerning the operation and maintenance of this amplifier, please contact our Customer Service Department.

If the amplifier is operating satisfactorily, the trouble may be attributed to the following:

1. Incorrect connections to or loose terminal contact with the speakers, record player, tape recorder or deck, line cord etc.
2. Incorrect operation of the amplifier and/or other components.
3. Improper positioning of the components such as speakers and record player.
4. Defective component or components connected to the amplifier.

The next step to do is listed below:

PROGRAM SOURCE	SYMPTOM	PROBABLE CAUSE	WHAT TO DO
Tuner	Noise is heard continuously or intermittently at a particular time of a day or in a certain area.	<ul style="list-style-type: none"> <li>* Discharge or oscillation caused by electrical appliances, such as fluorescent lamp, TV set, a.c. motor, rectifier, oscillator etc.</li> <li>* Insufficient antenna input or reception in fringe area</li> <li>* Wave interference</li> <li>* Natural phenomena, such as atmospherics, statics, strays and thunderbolt</li> </ul>	<ul style="list-style-type: none"> <li>* Attach a noise limiter to the electrical appliance that causes the noise, or attach it to the tuner.</li> <li>* Keep the said electrical appliance well away from the tuner.</li> <li>* Install an outdoor antenna and ground the amp to raise the signal-to-noise ratio.</li> <li>* If the noise occurs at a certain frequency, attach a wave trap to the ANT input.</li> <li>* Reverse the power cord plug-receptacle connections.</li> </ul>
	During AM reception, noise is heard at a particular time of a day, in a certain area or over part of dial.	<ul style="list-style-type: none"> <li>* Field intensity of AM signals</li> </ul>	<ul style="list-style-type: none"> <li>* Reset AM antenna for better reception</li> <li>* Ground the amp, or reverse the power cord plug-receptacle connections.</li> </ul>
	High-frequency noise is heard during AM reception.	<ul style="list-style-type: none"> <li>* Beat interference, i.e., interaction of two stations closely spaced</li> <li>* TV set close to the audio system</li> </ul>	<ul style="list-style-type: none"> <li>* The noise caused by beat interference cannot be completely eliminated. But it is advisable to turn the TREBLE control to the minimum counterclockwise position and turn the HIGH filter</li> <li>* Keep the TV set well away from the audio system.</li> </ul>

PROGRAM SOURCE	SYMPTOM	PROBABLE CAUSE	WHAT TO DO
	Noise during FM reception  Note: FM reception is affected considerably by the conditions of transmission by stations: power and antenna efficiency. As a result, you may receive one station quite well while having difficulty in receiving another station.	* Poor noise limiter effect or too low S/N ratio due to insufficient antenna input	* Install the antenna for maximum signal strength. * If this does not prove effective, use an outdoor antenna designed exclusively for FM. * When you make use of an existing TV antenna for this purpose, attach a divider to prevent interaction. * Note that excessively long antenna may rather cause a noise.
	Noise is heard suddenly during FM reception.	* Ignition noise caused by starting of an automobile engine	* Keep the antenna and its lead-in wire well away from the road side. Or raise the antenna input as described above.
	Noise is heard during FM stereo reception while being not heard during FM mono.	* The service area of FM stereo broadcast is only half as much as that of the FM mono.	* Install the antenna for maximum antenna input. * Turn on the HIGH filter and/or turn the TREBLE control to the minimum counterclockwise position.
Record player, tape recorder or deck	Hum or howling	* Record player placed directly on the speaker box * Connecting wire not shielded * Loose terminal contact * Connecting cord too close to the power cord, fluorescent lamp or other electrical appliances * Nearby amateur radio station or TV transmission antenna	* Put a cushion between record player and speaker box or keep them away from each other. * Use shielded cord. * Switch on the LOW filter and/or turn the BASS control from midpoint to left. * Make connecting cord as short as possible. * Connect cord tightly at terminals. * Keep connecting cord well away from them. * Consult the nearest Radio Regulatory Bureau.
	Surface noise	* Worn or old record * Worn or dusty pickup needle. * Improper needle pressure	* Turn the TREBLE control properly from mid-point to left and/or switch on the HIGH filter. Adjust the needle pressure.
Common to all program sources	The BALANCE control is not at the midpoint when equal sound comes from left and right channel.	* The BALANCE control is not always set to the midpoint depending the source materials.	* Proper balance exists when the sound seem to originate at a point midway between the speakers.

# PARTS LAYOUT

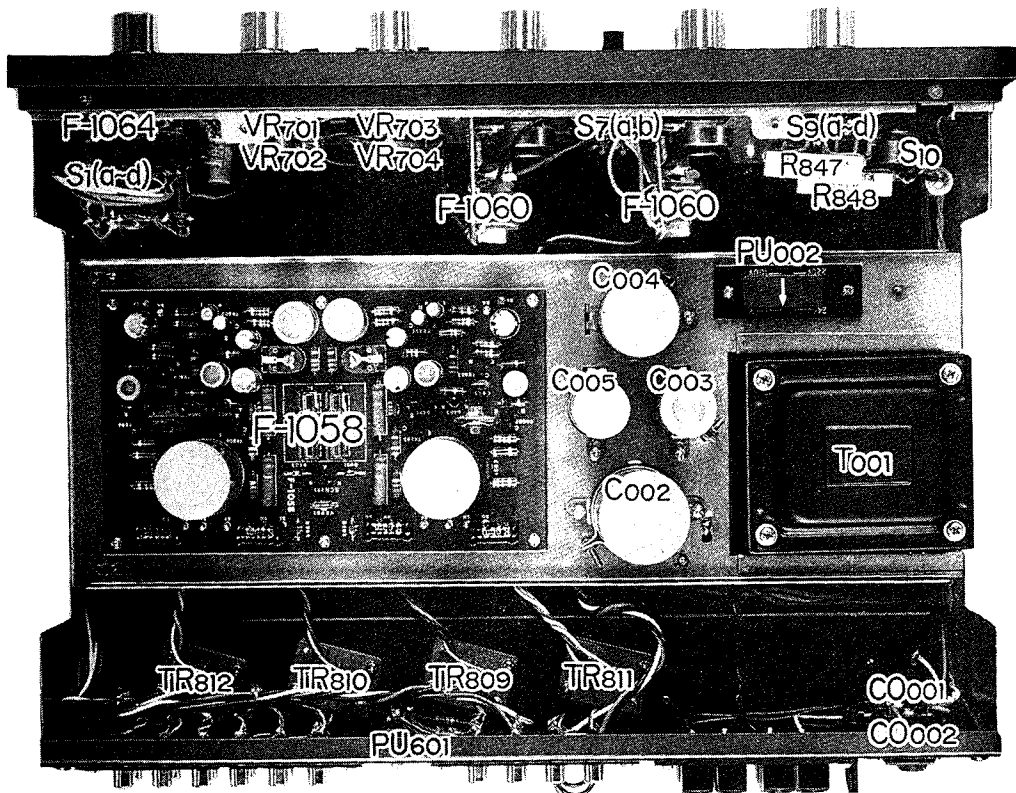
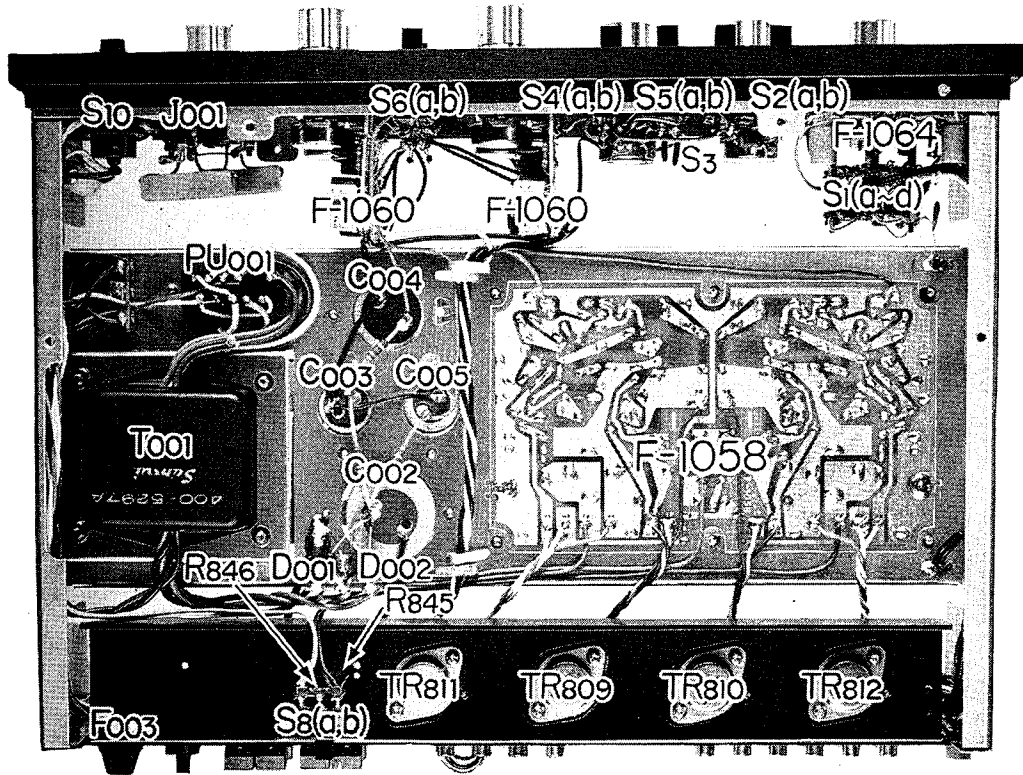

# DISASSEMBLY PROCEDURE

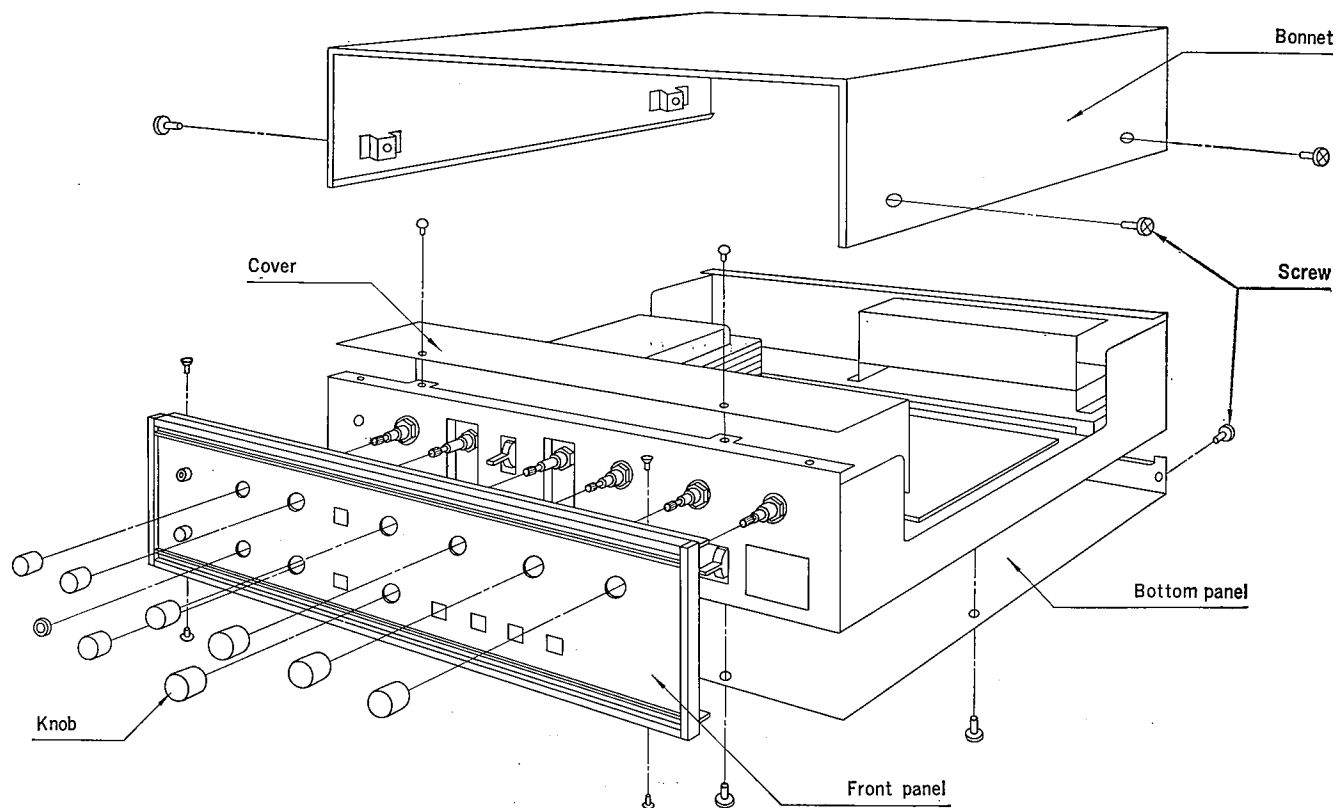



# MOUNTING TEMPLATE

This diagram shows the size and dimensions required for mounting the AU-555 into a custommade cabinet. Note that ample space is provided for complete air circulations above and below the tuner.

1. Be sure the cabinet window measures  $14\frac{41}{64}'' \times 4\frac{1}{16}''$  as indicated in the diagram.
2. Place two boards on the floor of the cabinet as illustrated. Boards should measure  $\frac{25}{32}'' \times \frac{25}{32}'' \times 7\frac{1}{8}''$ .
3. Drill two holes in the bottom of the cabinet at points corresponding to holes in the bottom of the tuner.
4. Take off the bonnet.
5. Remove the four rubber feet from the AU-555. (Retain for future use.)
6. Insert the AU-555 into the cabinet through the window until the edges of its front panel are flush with the cabinet, and secure both tuner and cabinet with washers and butterfly bolts provided

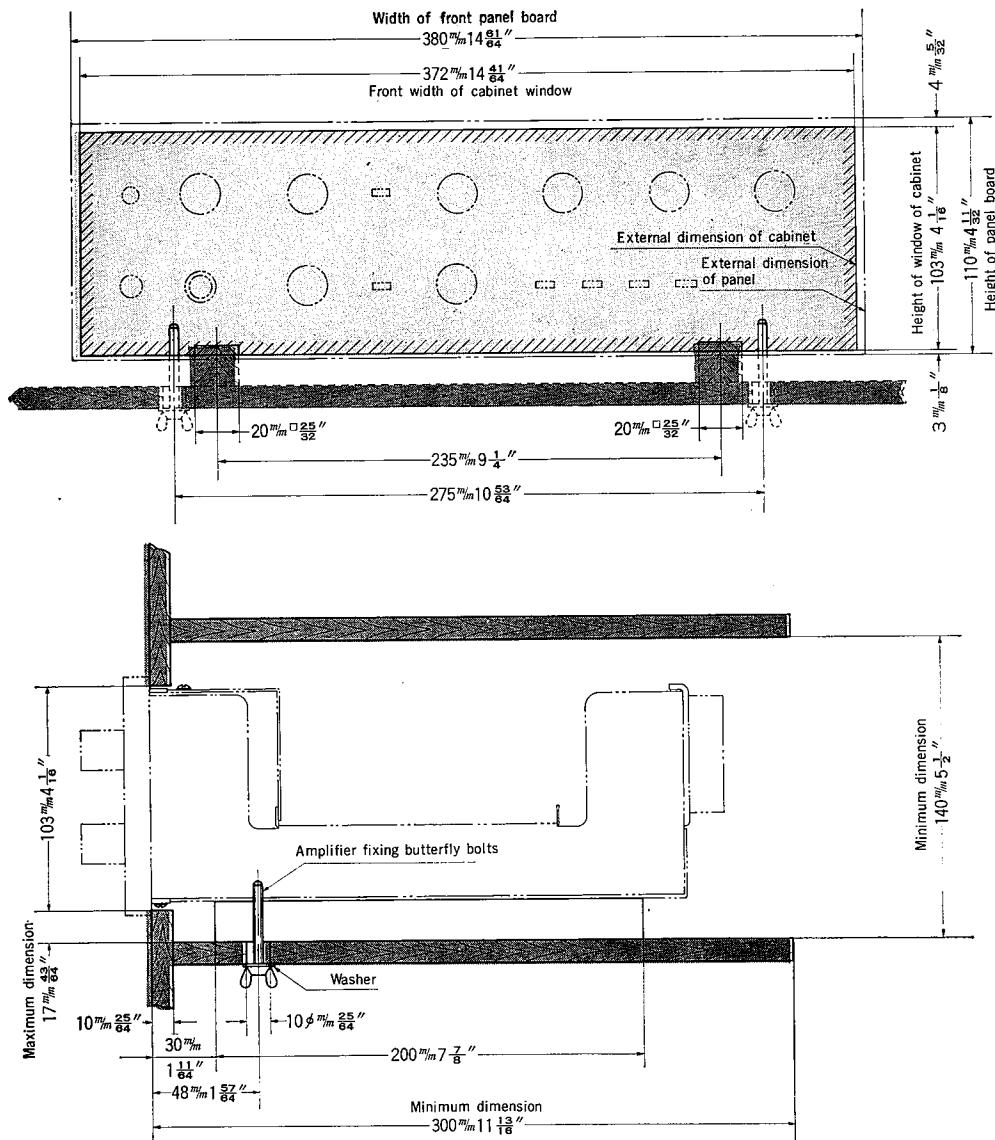
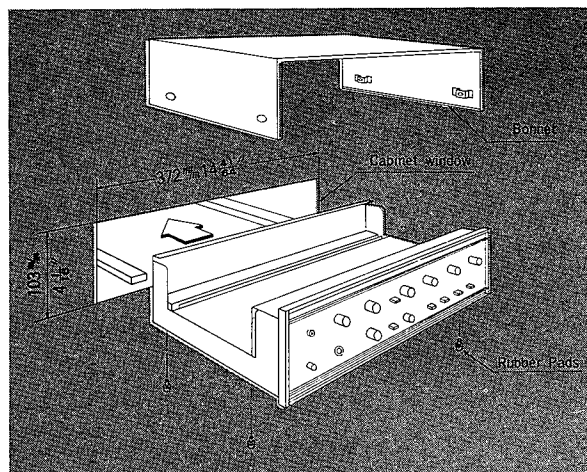

# BLOCK DIAGRAM

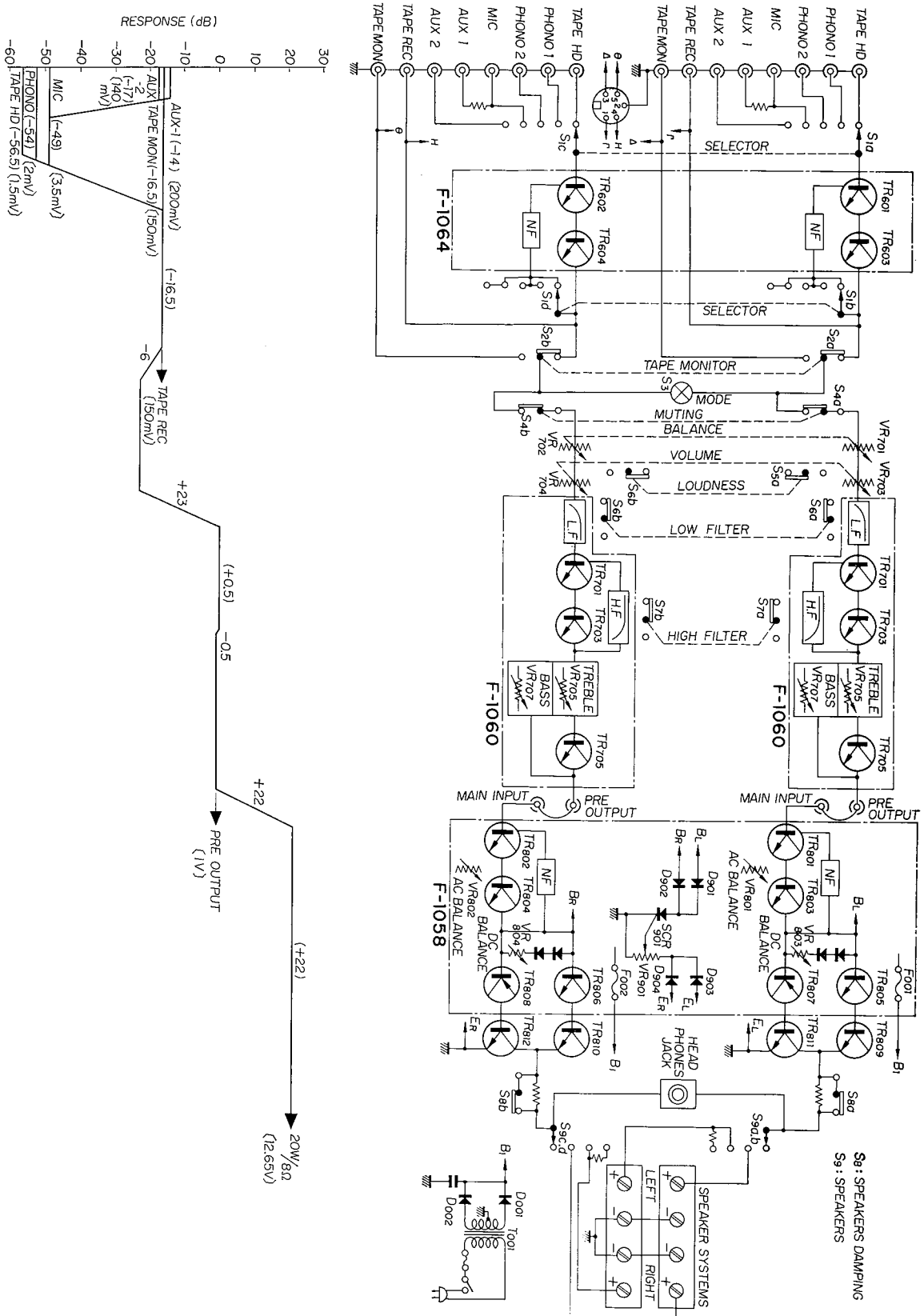

# ALIGNMENT

## MAIN-AMP SECTION OUTPUT ADJUSTMENT

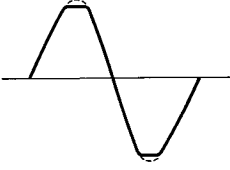
STEP	CONNECTIONS & ALIGN	REMARKS
1.	Set VOLUME control to minimum.	Oscilloscope required: oscillation frequency of 20 to 20,000 Hz and output voltage of more than 2000mV.
2.	Set oscillator to 1,000Hz and connect it to AUX 2 of channel L.	
3.	Set FUNCTION selector switch to AUX 2	When measuring, BALANCE control to mid-position, TAPE MONITOR switch to SOURCE, MODE switch to STEREO, TONE, controls to 0 and other accessory switches to OFF position.
4.	Connect a 8-ohm (or 16-ohm) load resistor (minimum rating of 30 watts) to SYSTEM A LEFT speaker terminal.	
5.	Set SPEAKER selector switch to SYSTEM A.	
6.	Connect oscilloscope to speaker terminal.	
7.	Turn POWER switch ON; turn VOLUME control clockwise little by little; and check output at speaker terminal by using oscilloscope.	
8.	Adjust VR <sub>801</sub> so that both crests of output wave form are clipped.  For channel R, follow same procedure as above. In Step 8, adjust VR <sub>803</sub> for clipped crests of output wave.	

## MAIN-AMP SECTION CURRENT ADJUSTMENT

STEP	AMMETER (TESTER)	CONNECTIONS & ALIGN	REMARKS
1.		Remove F <sub>001</sub> and F <sub>003</sub>	Ammeter required: 100mA or 50mA range
2.		Set VR <sub>803</sub> and VR <sub>804</sub> to minimum clockwise position.	
3.		Turn POWER switch ON.	
4.	Set to 100mA range.	Set ammeter in place of F <sub>001</sub> . Connect its ⊕ terminal to 8I, and its ⊖ terminal to 8C in schematic diagram.	Be sure to turn POWER switch on and then connect ammeter.
5.		Turn VR <sub>803</sub> and adjust current to 22~26mA at room temperature of less than 25°C and to 18~22mA at more than 25°C.	
6.		Turn POWER switch OFF and reset F <sub>001</sub> to its original position.	
7.	Set to 100mA range.	Turn POWER switch ON and set ammeter in place of F <sub>002</sub> . Connect its ⊕ terminal to 8I, and its ⊖ terminal 8C in schematic diagram.	
8.		Turn VR <sub>804</sub> and adjust current to 22~26mA at room temperature of less than 25°C and to 18~22mA at more than 25°C.	

# MAIN AMP ALIGNMENT

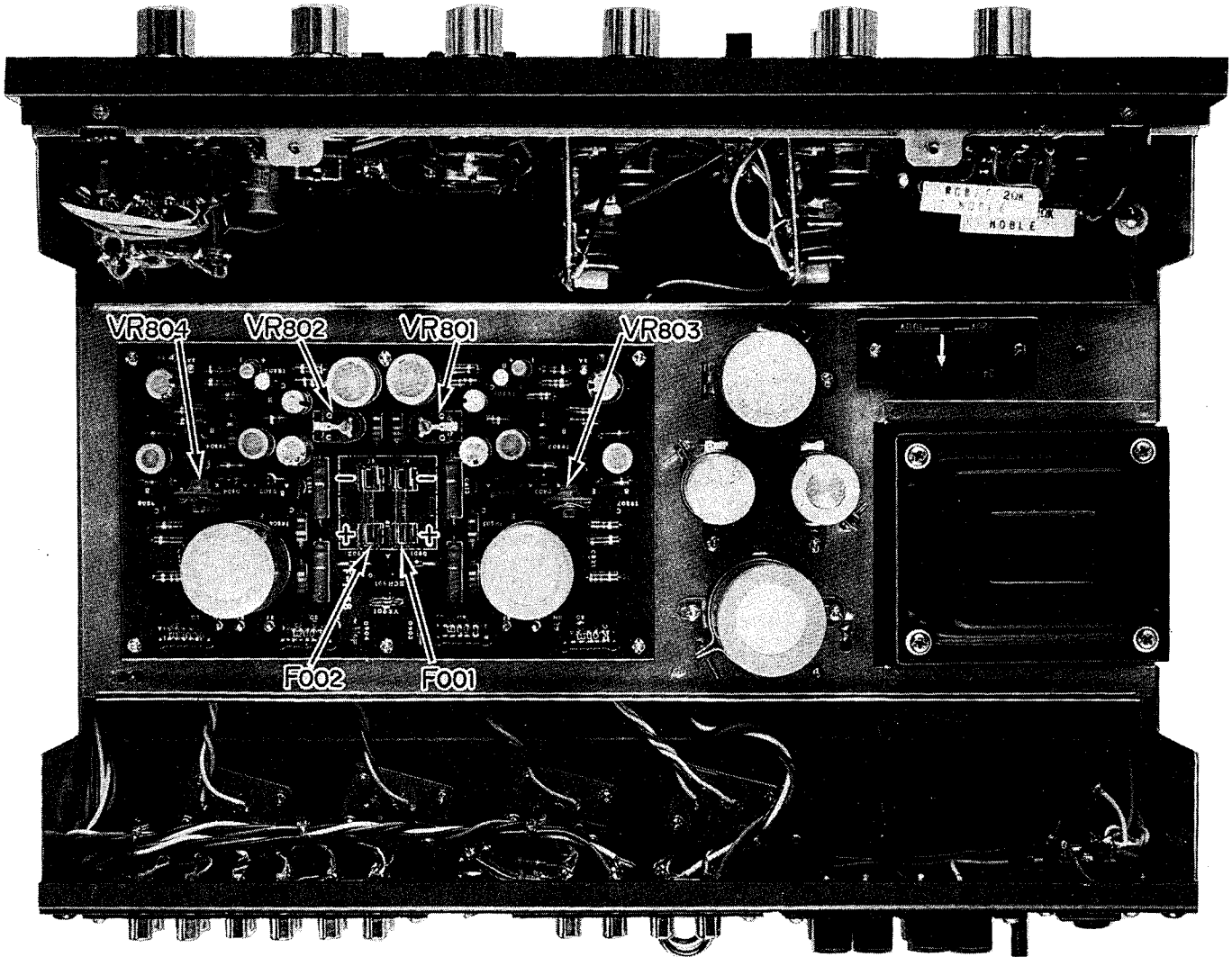

# PRINTED CIRCUIT SHEETS AND PARTS LIST

## HEAD AMP <F-1064>

X	Y	Z
R601	2.2KΩ ¼W ±10% Carbon Resistor	2A
R602	2.2KΩ ¼W ±10% Carbon Resistor	1A
R603	680KΩ ¼W ±10% Carbon Resistor	2A
R604	680KΩ ¼W ±10% Carbon Resistor	1A
R605	220KΩ ¼W ±10% Carbon Resistor	2A
R606	220KΩ ¼W ±10% Carbon Resistor	1A
R607	2.2KΩ ¼W ±10% Carbon Resistor	2A
R608	2.2KΩ ¼W ±10% Carbon Resistor	1A
R609	270KΩ ¼W ±10% Carbon Resistor	2A
R610	270KΩ ¼W ±10% Carbon Resistor	1A
R611	8.2KΩ ¼W ±10% Carbon Resistor	2B
R612	8.2KΩ ¼W ±10% Carbon Resistor	1B
R613	220Ω ¼W ±10% Carbon Resistor	2A
R614	220Ω ¼W ±10% Carbon Resistor	1A
R615	560Ω ¼W ±10% Carbon Resistor	2B
R616	560Ω ¼W ±10% Carbon Resistor	1B
R617	82KΩ ¼W ±10% Carbon Resistor	2B
R618	82KΩ ¼W ±10% Carbon Resistor	1B
R619	100Ω ¼W ±10% Carbon Resistor	2C
R620	100Ω ¼W ±10% Carbon Resistor	1B
R621	470Ω ¼W ±10% Carbon Resistor	2B
R622	470Ω ¼W ±10% Carbon Resistor	1B
R623	4.7MΩ ¼W ±10% Carbon Resistor	2B
R624	4.7MΩ ¼W ±10% Carbon Resistor	1C
R625	12KΩ ¼W ±10% Carbon Resistor	2B
R626	12KΩ ¼W ±10% Carbon Resistor	1C
R627	470KΩ ¼W ±10% Carbon Resistor	2C
R628	470KΩ ¼W ±10% Carbon Resistor	1C
R629	22KΩ ¼W ±10% Carbon Resistor	2C

X: Parts No Y: Parts Name Z: Position of Parts  
(Co-ordinate number and letter in printed circuit)

X	Y	Z
R630	22KΩ ¼W ±10% Carbon Resistor	1C
R631	15KΩ ¼W ±10% Carbon Resistor	2C
R632	15KΩ ¼W ±10% Carbon Resistor	1B
C601	1.5μF 15 WV Tantalum	2A
C602	1.5μF 15 WV Tantalum	1A
C603	150 pF ±10% 50 WV Mica	2A
C604	150 pF ±10% 50 WV Mica	1A
C605	220μF 6.3 WV Electrolytic Condenser	2A
C606	220μF 6.3 WV Electrolytic Condenser	1A
C607	47 pF ±10% 50 WV Mica	2A
C608	47 pF ±10% 50 WV Mica	2A
C609	10μF 50 WV Electrolytic Condenser	2B
C610	10μF 50 WV Electrolytic Condenser	1B
C611	47μF 6.3 WV Electrolytic Condenser	2A
C612	47μF 6.3 WV Electrolytic Condenser	1A
C613	0.004μF ±10% 50 WV Mylar	2B
C614	0.004μF ±10% 50 WV Mylar	1C
C615	0.01μF ±10% 50 WV Mylar	2C
C616	0.01μF ±10% 50 WV Mylar	1B
C617	0.0033μF ±10% 50 WV Mylar	2C
C618	0.0033μF ±10% 50 WV Mylar	1C
TR601	2SC458LG@ 030531-1	2A
TR602	2SC458LG@ 030531-1	1A
TR603	2SC458LG@ 030531-1	2A
TR604	2SC458LG@ 030531-1	1A

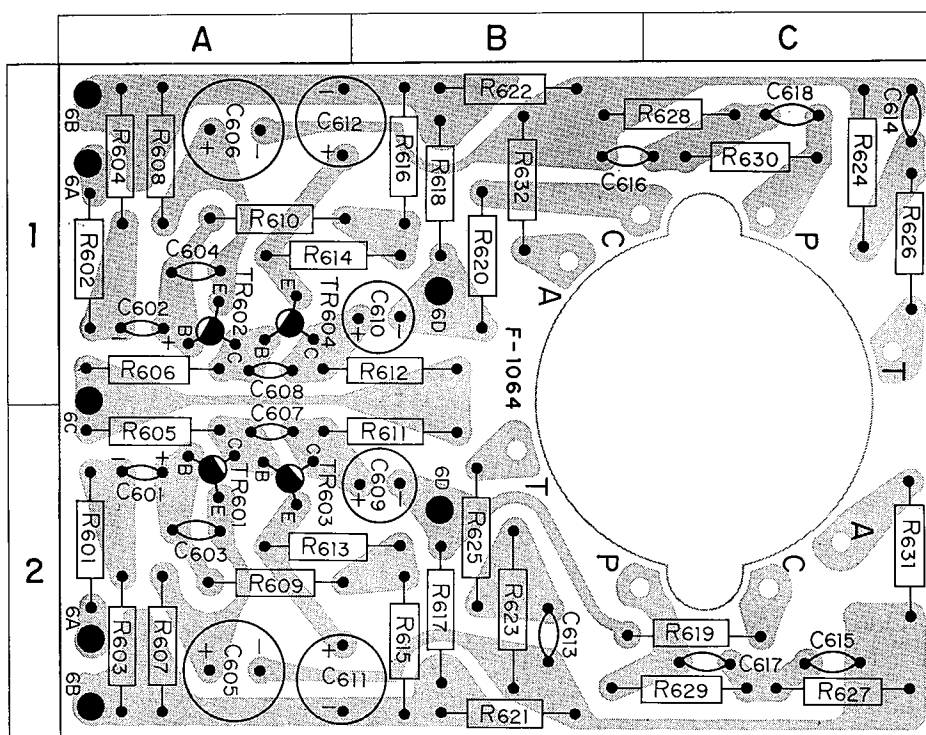

# CONTROL AMP <F-1060>

X	Y	Z
R705	47KΩ ¼W ±10% Carbon Resistor	2A
R707	68KΩ ¼W ±10% Carbon Resistor	2A
R709	220KΩ ¼W ±10% Carbon Resistor	1A
R711	1.5KΩ ¼W ±10% Carbon Resistor	2A
R713	220KΩ ¼W ±10% Carbon Resistor	2A
R715	5.6KΩ ¼W ±10% Carbon Resistor	1A
R717	22KΩ ¼W ±10% Carbon Resistor	2A
R719	1.5KΩ ¼W ±10% Carbon Resistor	2B
R721	10KΩ ¼W ±10% Carbon Resistor	1B
R723	4.7KΩ ¼W ±10% Carbon Resistor	1B
R725	10KΩ ¼W ±10% Carbon Resistor	1B
R727	10KΩ ¼W ±10% Carbon Resistor	1C
R729	680KΩ ¼W ±10% Carbon Resistor	1C
R731	330KΩ ¼W ±10% Carbon Resistor	2C
R733	5.6KΩ ¼W ±10% Carbon Resistor	1C
R735	3.3KΩ ¼W ±10% Carbon Resistor	2B
R737	100KΩ ¼W ±10% Carbon Resistor	2C
R739	330KΩ ¼W ±10% Carbon Resistor	1B
C705	0.015μF ±10% 50 WV Mylar	2A
C707	0.22μF ±10% 50 WV Mylar	2A
C709	47 pF ±10% 50 WV Mica	1A

X: Parts No Y: Parts Name Z: Position of Parts  
(Co-ordinate number and letter in printed circuit)

X	Y	Z
C711	47μF 6.3 WV Electrolytic Condenser	2B
C713	0.001μF ±10% 50 WV Mylar	2B
C715	10μF 25 WV Electrolytic Condenser	1B
C717	33μF 25 WV Electrolytic Condenser	2B
C719	0.0015μF ±10% 50 WV Mylar	1B
C721	0.047μF ±10% 50 WV Mylar	1C
C723	0.047μF ±10% 50 WV Mylar	1C
C725	10μF 25 WV Electrolytic Condenser	2B
C727	10μF 10 WV Electrolytic Condenser	2B
C729	47 pF ±10% 50 WV Mica	2C
C731	47μF 6.3 WV Electrolytic Condenser	2C
C733	3.3μF 25 WV Electrolytic Condenser	2C
TR701	2SC458L(G,C) 030531-1	2A
TR703	2SC458L(B,C) 030542-1	2A
TR705	2SC458L(B,C) 030542-1	2C
VR705	100KΩ(B) 100018	1A
VR707	100KΩ(B) 100018	1C

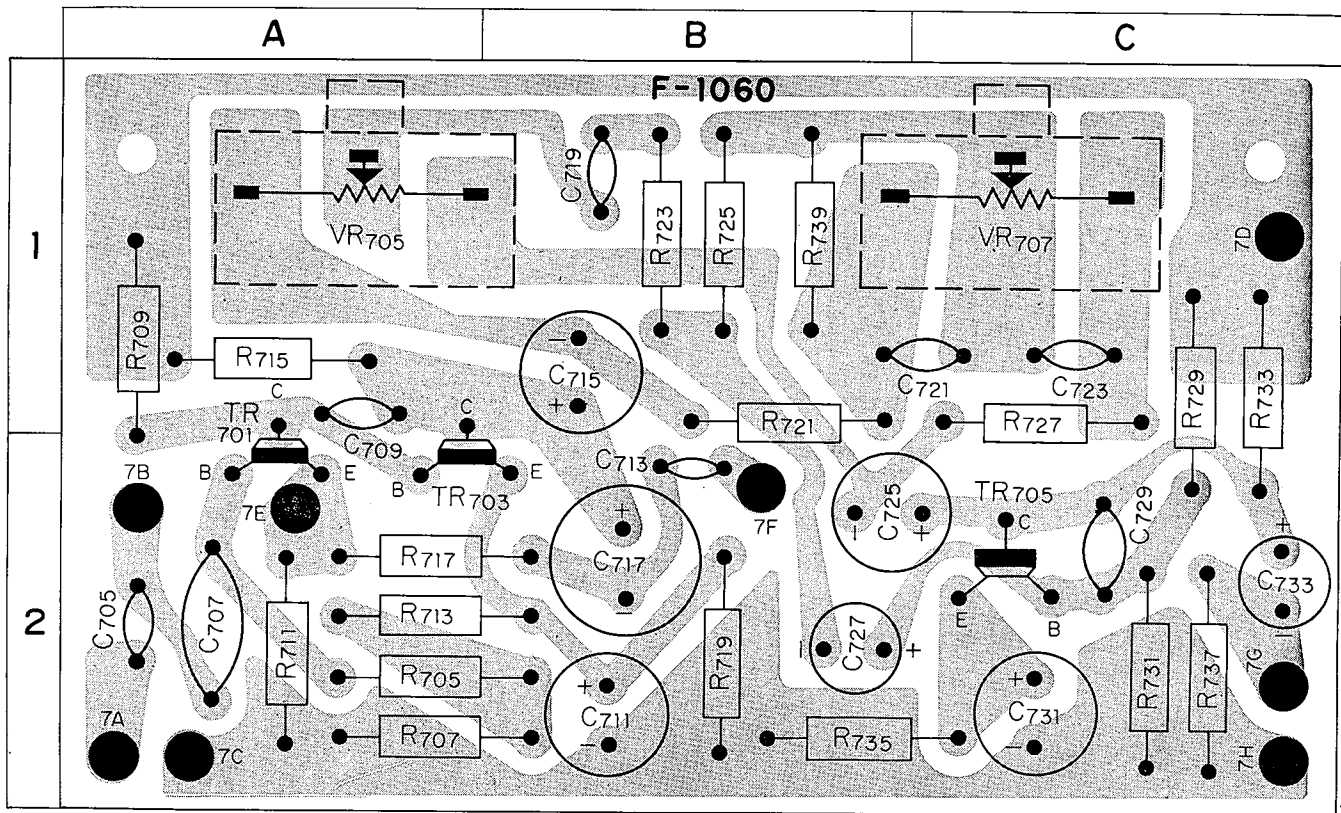

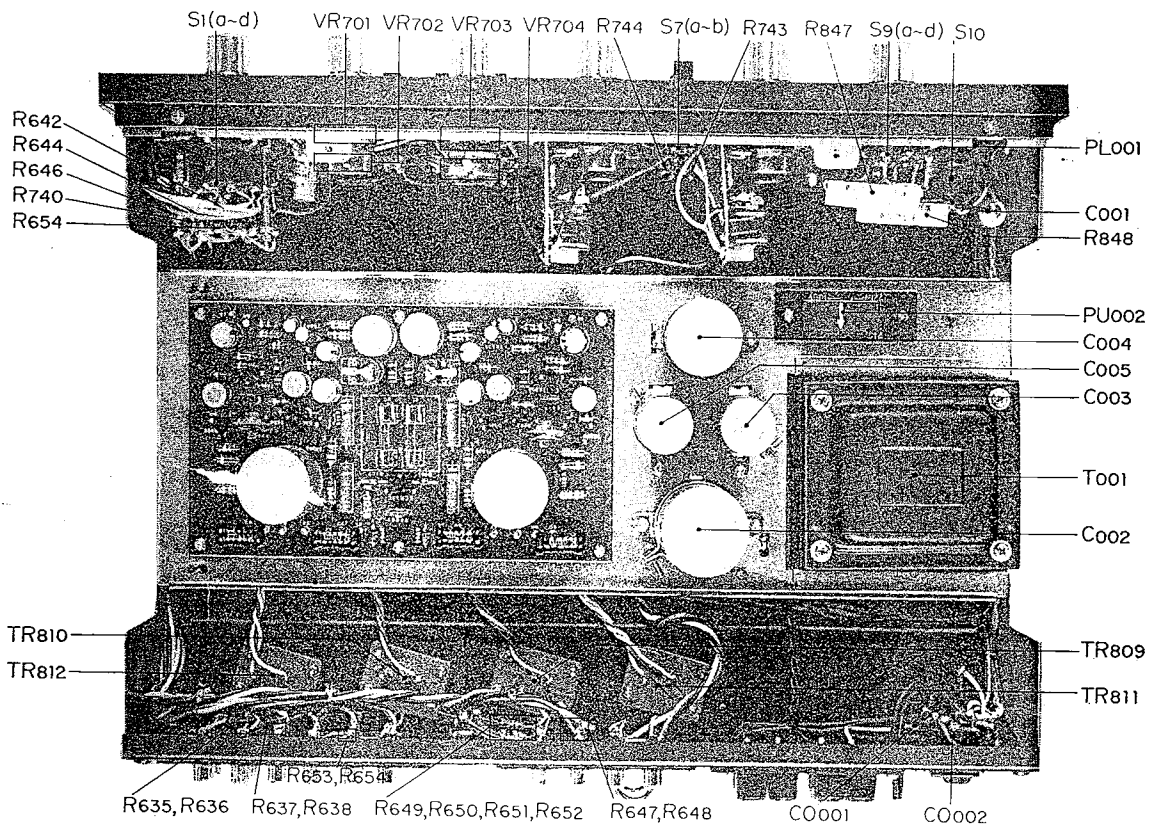
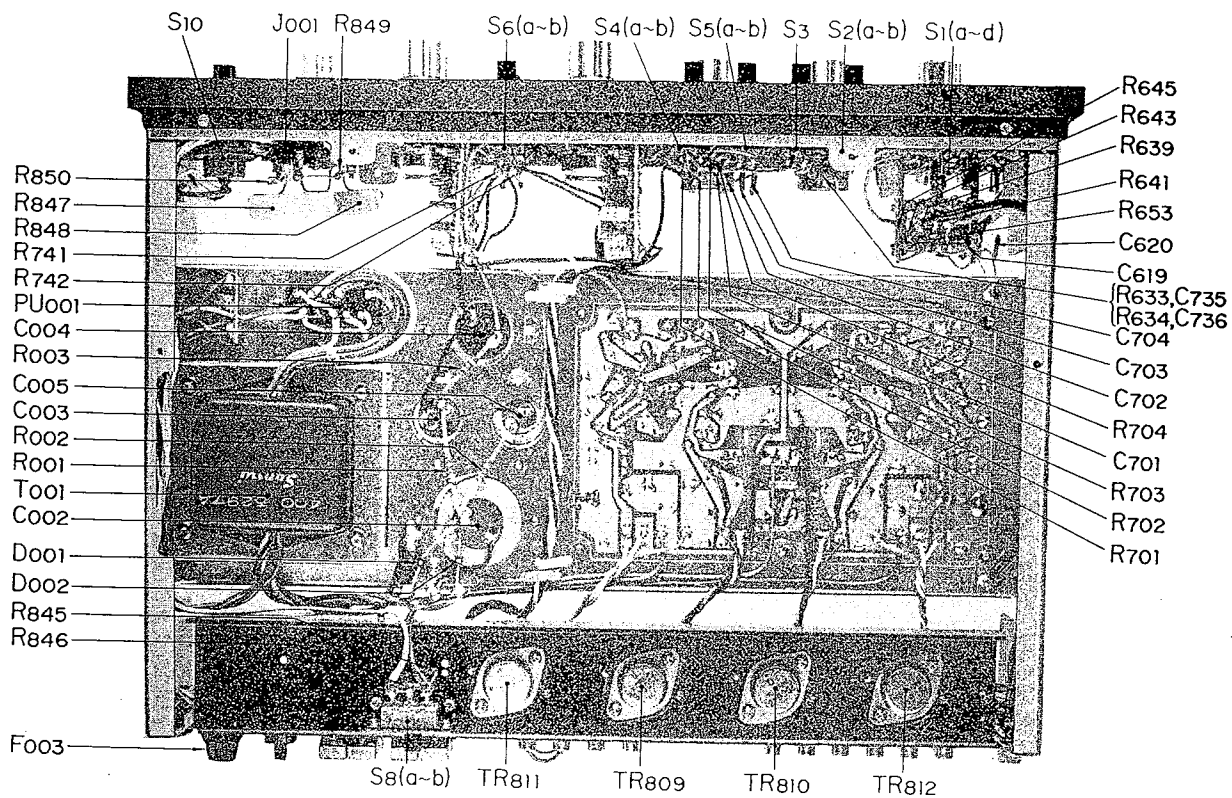



*Sansui*<sup>®</sup>



SANSUI ELECTRIC COMPANY LIMITED



Head Office ; 14-1, 2-chome, Izumi, Suginami-ku, Tokyo, Japan. TEL. 323-1111

---

Printed in Japan (39020M6)